

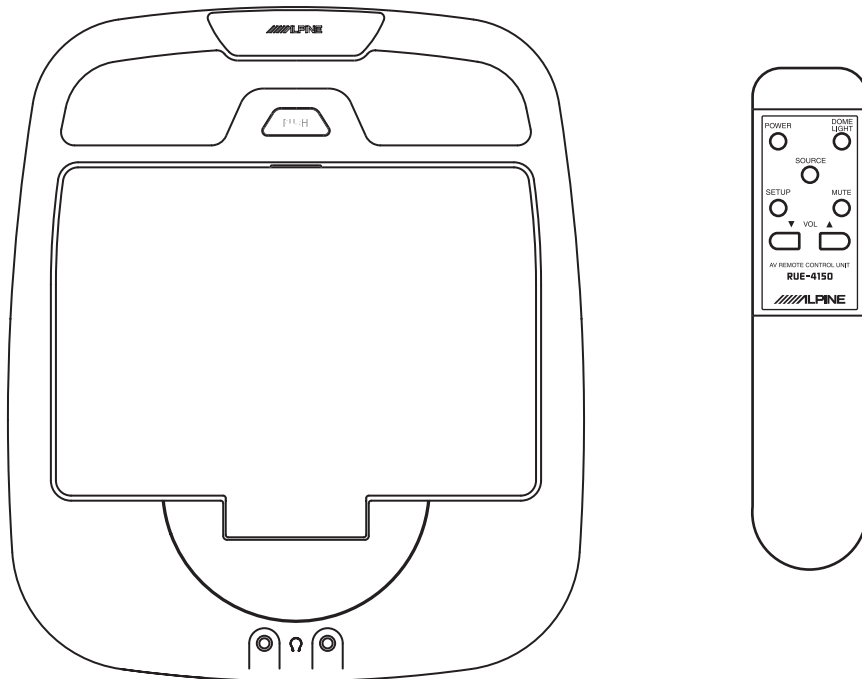

TMX-R680A

Mobile Overhead Monitor

OWNER'S MANUAL





WARNING

It is dangerous and illegal for the driver to watch the TV/Video while driving the vehicle. The driver may be distracted from looking ahead and an accident could occur.

Caution

- Read this manual thoroughly before starting installation and operation. You will find a number of Safety Warnings in this manual to tell you about things that could hurt you or other people if you were to ignore the Warnings. We cannot be responsible for problems resulting from failure to observe the Warnings in this manual.
- This manual uses a symbol to show how to use this product safely and to avoid harm to yourself and others and damage to your property. Here is what this symbol means. Understanding it is important for reading the Manual.
- Meaning of Symbol:



WARNING

This symbol means there is something that could cause serious injury or death to you or other people.

DO NOT DISASSEMBLE OR ALTER

Attempts to disassemble or alter this product can lead to accidental fires or electrical shock.

KEEP SMALL ARTICLES OUT OF THE REACH OF CHILDREN

Keep small articles (wire-ties, etc.) out of reach of children. If swallowed, consult a physician immediately.

USE ONLY IN CARS WITH A 12 VOLT NEGATIVE GROUND

Use only in cars with a 12 volt negative (-) ground electrical system. (Check with your dealer if you are not sure.)

Failure to do so may result in fire, etc.

BEFORE WIRING, DISCONNECT THE CABLE FROM THE NEGATIVE BATTERY TERMINAL

Before doing any electrical wiring, disconnect the cable from the negative (-) terminal of the battery. Failure to do so may result in electric shock or injury due to electrical shorts.

KEEP ELECTRICAL CABLES TOGETHER TO AVOID OPERATING HAZARDS

Dress the wiring to keep them from interfering with the operation of the steering wheel, gear lever, brake pedals, etc.

DO NOT CUT AWAY ANY WIRE INSULATION TO USE ITS POWER FOR OTHER EQUIPMENT

Tapping power from wiring to supply voltage to another piece of equipment could exceed the current carrying capacity of that wire. This could result in fire or electric shock.

DO NOT INSTALL IN LOCATIONS WHICH MIGHT HINDER VEHICLE OPERATION

Do not install in locations which might create hazards for the vehicle occupants or hinder vehicle operation (such as the steering wheel or gear shift) by obstructing forward vision or hampering movement etc.

DO NOT DAMAGE PIPES OR WIRING WHEN DRILLING HOLES

When drilling holes in the chassis for installation, take precautions so as not to contact, damage or obstruct pipes, tanks or electrical wiring. Failure to take such precautions may result in fire.

DO NOT USE NUTS OR BOLTS IN THE BRAKE SYSTEM FOR INSTALLATION OR GROUND CONNECTIONS

Never use safety-related parts such as bolts or nuts in the steering or brake systems or tanks to make wiring installations or ground connections. Using such parts could disable control of the vehicle and cause fire etc.

HALT USE IMMEDIATELY IF A PROBLEM APPEARS

When problems appear, stop using the system immediately and contact the dealer from whom you purchased the equipment. Some problems which may warrant immediate attention include a lack of sound, noxious odors or smoke being emitted from the unit, or foreign objects dropped inside the unit.

DO NOT OPERATE THE EQUIPMENT OR LOOK AT THE SCREEN WHILE DRIVING

Do not change settings while driving. If operation requiring a prolonged view of the display is required, stop the vehicle in a safe location before attempting operation.

DO NOT INSTALL THE MONITOR NEAR THE PASSENGER SEAT AIR BAG

Ensure that the location chosen for the monitor does not interfere with the operation of the passenger seat air bag. This will prevent the triggered air bag from launching the display towards passengers, possible causing injury.

HAVE THE WIRING AND INSTALLATION DONE BY EXPERTS

The wiring and installation of this unit requires special technical skill and experience. To ensure safety, always contact the dealer where you purchased this unit to have the work done.

DO NOT INSTALL IN LOCATIONS WITH HIGH MOISTURE OR DUST

Avoid installing the unit in locations with high incidence of moisture or dust. Moisture or dust that penetrates into this unit may cause smoke or fire.

MAKE THE CORRECT CONNECTIONS

Failure to make the correct connections can cause fire or accident to occur.

ARRANGE THE WIRING SO IT IS NOT CRIMPED OR PINCHED

Route the cables and wiring so as not to be crimped by moving parts like seat rails or to make contact with sharp spots which could damage the wiring.

DO NOT RAISE THE VOLUME EXCESSIVELY

Keep the volume at a level where you can still hear outside noises while driving. Driving while unable to hear outside sounds could cause an accident.

FEATURES/DESCRIPTION

Alpine's TMX-R680A integrates a 6.8 inch color LCD panel, infrared transmitter for wireless headphones, dual video source selector, and remote controllable dome light. This gives the passengers in the rear seats of your vehicle, the ability to enjoy many different A/V sources (such as a VCR, DVD, TV Tuner and Video Game). The TMX-R680A combines all these features into a single pod mounted to the vehicles head liner. Alpine's SmartView™ swivel mechanism was designed to give the rear seat passengers flexibility in adjusting the monitor for the best picture possible from any angle.



WARNING

It is dangerous and illegal for the driver to watch TV/Video while driving any vehicle. The driver may be distracted from looking ahead and an accident could occur.

Features:

Dual A/V Inputs

Including one, 5m, mini-DIN extension to connect either of the 2 inputs to an A/V source. The Mini-DIN to RCA interface converts the DIN input to standard RCA-type. The two inputs are selected using the wireless remote control.

Single A/V Output

An auxiliary A/V output is provided to you to send video and audio to an additional monitor. This signal mirrors what's being shown on the TMX-R680A display.

Dual Headphone Outputs (wired)

Two headphone output jacks help to reduce interference from other audio sources. Infrared, wireless headphones can also be used thanks to the built-in IR transmitter array.

Dome Light (3-way Controllable)

The integrated dome light has its own DC source (yellow/green wire). This wire, along with one of the control wires must be connected for the Dome light to operate properly. Operation can also be controlled through the wireless remote control. A Delayed Dome Light function can also be programmed, if desired.

Wireless Remote Control (w/Remote Output for external source)

IR Transmitter for wireless headphones

Wireless IR Headphone (SHS-N101) compatible

Variable Audio Output

OSD (On-screen Display)

Note:

If you have any questions regarding the application of this device, see your authorized Alpine dealer.

It is recommended that this product be used with Alpine's various Overhead Consoles. Your authorized Alpine dealer will have more information on these products.

See page 14 for a typical Entertainment system using the TMX-R680A.

OPERATION - Overhead Monitor

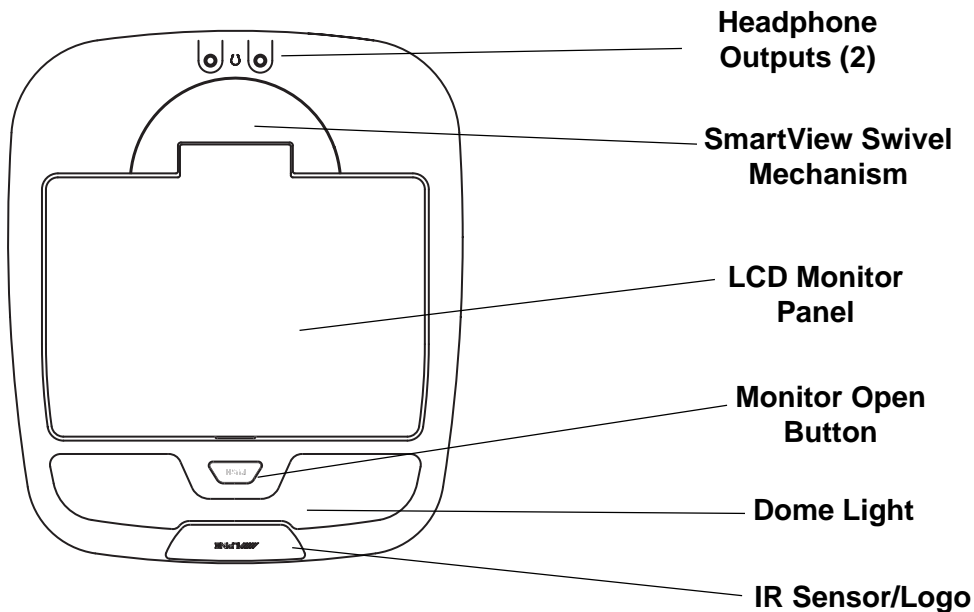

Headphone Outputs

Two output jacks (mini-phono plug) are provided for wired headphones. Output level is adjusted using the Volume UP/DN buttons on the remote control.

NOTE:

- Plugging a headphone into either jack will mute the Variable Audio Output.

SmartView Swivel Mechanism

The design of this mechanism provides the rear seat passengers a stable picture, viewable from many different angles. This system allows the LCD to tilt from 90 to 120 degrees in 10 degree steps. At the same time, the LCD will maintain its horizontal view while being rotated from left to right, up to 30 degrees, in 10 degree steps.

NOTE:

- The LCD will only close when rotation is at 0 degrees to prevent damage to the monitor.
- When rotating the monitor, use both hands on either side of the panel to ensure even pressure on the mechanism. This will prevent damage to the SmartSwivel mechanism.
- Make sure the panel is fully opened (90 degree position) before trying to rotate.

LCD Monitor Panel

This is a 6.8 inch, TFT, Active Matrix, LCD. In addition, an Infrared Wireless Headphone transmitter is located on both sides of the LCD panel. When the monitor panel is closed, the power is automatically turned off. Once power is OFF, power can only be turned ON by using the Power button on the remote control (even after the panel is reopened).

Monitor Open Button

Press this button to release the Monitor Panel. The Panel will drop down slightly allowing you to fully open to its 90 degree or greater position. To close, firmly press the LCD Monitor Panel back up into the housing until a click is heard.

IR Sensor/Logo

There is an IR Sensor that receives the Remote Control commands at the front of the housing. At this same location is a back-lit Alpine logo which acts as the main power indicator.

OPERATION - Dome Light/Remote Control

Dome Light

The built-in Dome Light has three modes of operation:

1) External Dome Light Switch

In this mode, the Dome Light is controlled by an externally mounted switch. This mode is the lights highest priority and supersedes all other modes of operation.

Two wires are used to control this operation:

Dome Light ALWAYS ON —> Ground (Dome Light stays ON)

Dome Light ALWAYS OFF —> Ground (Dome Light stays OFF)

2) Vehicle Door Open/Close

When connected to the factory door switch, the Dome Light will operate in conjunction with the opening and closing of the vehicle's doors. If the External Dome Light Switch is being used, it must be disabled in order to this mode to operate properly.

3) Dome Light Remote Button

The Dome Light can be turned ON at any time, using the Dome Light button on the Remote Control. Again, the External Switch must be disabled in order for this mode to operate. Also, if the Dome Light is turned on using the Door Switch, the Dome Light button on the Remote Control can turn it OFF.

Additional Dome Light Feature

The TMX-R680 has an additional feature for controlling the built-in Dome Light. This gives the installer added flexibility in integrating the system into a vehicle.

• Door Trigger OFF Mode

In case the customer does not wish to install an external Dome Light Switch, the Door Trigger OFF mode may still be set. In this mode, the Dome Light will not turn ON even if the door is opened.

Activate the Door Trigger OFF Mode:

Make sure that the door is open and the Dome Light is ON. Press and Hold the Dome Light button for at least 3 seconds. The Dome Light will turn OFF and the Door Trigger OFF Mode is activated. Once this mode is set, the Dome Light will not turn ON even if the door is opened.

NOTE: The Remote Control still controls the Dome Light while the Door Trigger OFF Mode is activated.

Deactivate the Door Trigger OFF Mode:

Make sure the door is open and the Dome Light is OFF. Press and Hold the Dome Light button for at least 3 seconds. The Dome Light will turn ON and the Door Trigger OFF mode is deactivated. The door will now control the Dome Light.

• Delayed Dome Light

If the user would like to have a delayed Dome Light in his/her vehicle, the TMX-R680A can be programmed for this feature. Please see page 12.

OPERATION - Dome Light/Remote Control

REMOTE CONTROL

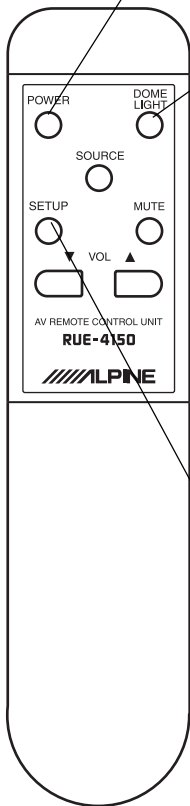

Power

Press this button to turn Main Power to the TMX-R680A ON or OFF (Ignition/ACC must be ON and the LCD Panel must be open). Closing the LCD Panel turns Main Power OFF automatically.

NOTE:

Once power has been turned OFF, the Power button must be pressed to turn it back ON.

Dome Light

Press to turn the Dome Light ON or OFF. If the Dome Light trigger wires have been connected to a switch, the button operates in the following manner:

SWITCH POSITION

- 1) OFF - Dome light remains OFF at all times, even when the Dome Light button is been pressed. The Dome light will remain OFF until the switch is turned OFF.
- 2) ON - The Dome light remains ON at all times, even when the Dome Light button is pressed. To turn the light OFF, this Switch must be OFF. The remote, DOOR or OFF triggers will then turn the Dome light OFF.
- 3) DOOR - The Dome light will turn ON and OFF whenever the vehicle's doors are open or closed respectively. Pressing the DOME button toggles the Dome light ON or OFF depending upon its present state.

Setup

Press the Setup button to make adjustments to the picture.

The various options will rotate in the following order:

(Blank) → CONTRAST → BRIGHTNESS → COLOR → TINT

Once the parameter you want to change is on the screen, use the Volume UP or DN buttons to increase or decrease the level respectively. If no action is taken within 5 seconds after making the selection or adjustment, the Setup mode is ended and the OSD turns OFF. Also, by using the Setup button to cycle past TINT, you can end the Setup mode after TINT (Blank) as shown above.

OPERATION - Remote Control

REMOTE CONTROL (continued)

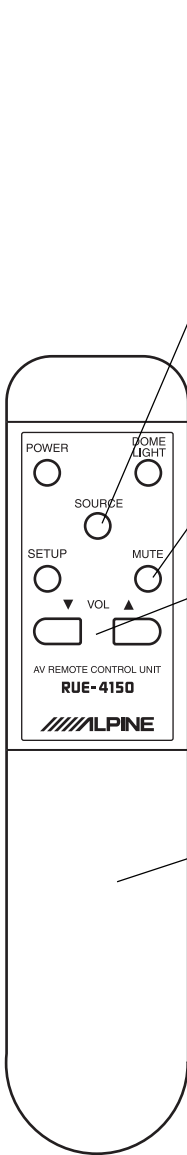

Source

Press the Source button to toggle between the two A/V sources (AV1 and AV2). As you toggle, the source will be displayed on the OSD (On Screen Display).

NOTE:

In addition to the Remote Control Source button, each A/V input has its own wired select trigger. This is called the External AV Select (Pink/Blue) wire.

Mute

Instantly mute the headphones or Variable Audio outputs by pressing this button. Pressing the Mute button again (or pressing either the Volume UP or DN button) will return the volume to its original level.

Volume

Use the volume UP and DN buttons to increase or decrease the headphone and Variable Audio output levels. Pressing and holding either button will increase or decrease the volume rapidly. The volume function does not affect the A/V Output.

Battery Compartment (AAA Battery x 2)

WIRING/CONNECTIONS

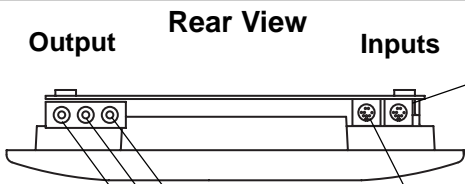

AV-1 Mini DIN-Connector

(Video, Audio L/R, IGN/ACC, GND, Remote, External AV Select 1)

This connector is the Video 1 Input. Use the 5m, mini-DIN extension in conjunction with the RCA Interface DIN to connect to any external A/V source.

AV-2 Mini-DIN Connector:

(Video, Audio L/R, IGN/ACC, GND, Remote, External AV Select 2)

This connector is the Video 2 Input. Use the 5m, mini-DIN extension in conjunction with the Mini-DIN to RCA Interface to connect to any external A/V source.

AUX Output, Video

AUX Output, Audio (Right)

AUX Output, Audio (Left)

An Auxiliary A/V output is provided to drive an external monitor. This signal mirrors what's being shown on the TMX-R680A display.

The volume function does not affect the Auxiliary A/V Output.

5m Mini-DIN Extension Cable



WIRING/CONNECTIONS

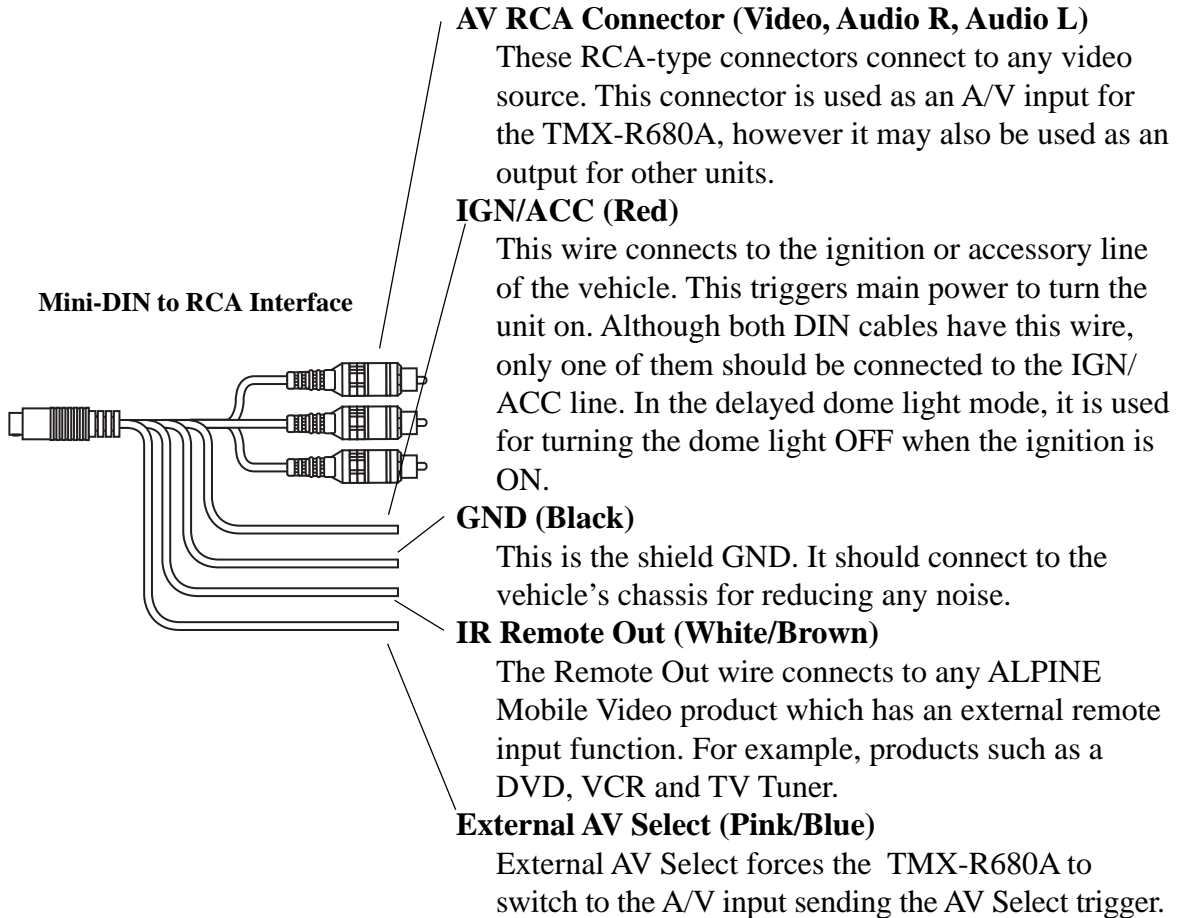

This trigger is a pulsed signal (Active Low, 500ms or more). If this input is remains low, switching to other sources is not possible (Switching sources using the Remote Control is still possible). This is useful if you don't want an AV source to be interrupted. Playing a video is a good example of this scenario. This function is mainly used for connecting with other ALPINE products.

WIRING/CONNECTIONS

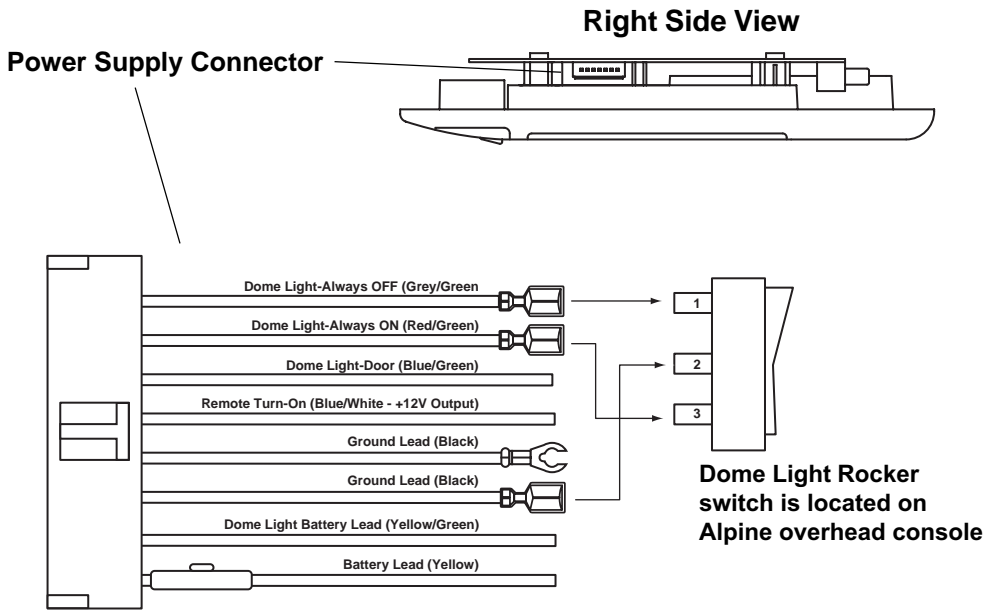

Cable Color

Dome Override (Always OFF)	Grey/Green
Dome Override (Always ON)	Red/Green
Dome Light (Door Trigger)	Blue/Green
Remote Turn ON	Blue/White
GND: Main Unit, Dome Light.....	Black
BATT (Dome Light)	Yellow/Green
BATT (Main Unit).....	Yellow

Dome Override (Always OFF)

Connecting to Pin #1 of the external dome light SW. When it is grounded, the Dome light remains off all the time.

Dome Override (Always ON)

Connect to Pin #3 of the external dome light SW. When it is grounded, the Dome light remains on all the time.

Dome Light (Door Trigger)

Connect to the factory door switch.

NOTE : Vehicle Door polarity depends on the vehicle type can be changed by the jumper SW where is located on the left side PCB in the overhead monitor. (Default: Negative Switched System)

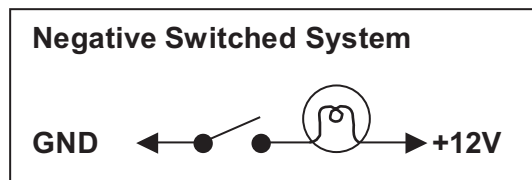
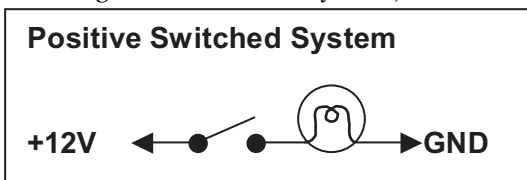

WIRING/CONNECTIONS

Remote Turn ON

Connecting to the IGN/ACC line for other ALPINE unit or other device such as a small amplifier to turn them ON synchronizing with the TMX-R680A power ON. It gives +12V when the power is ON.

GND

This is a common Ground for the main unit and the Dome light. Another GND line connects to Pin #2 of the external dome light SW.

BATT (Dome Light)

This is a constant +12V for the Dome light. Connect to the Dome light +12V line on the vehicle.

BATT (Main Unit)

This is a constant +12V for the main unit. It is recommended that separate connections from the Dome light battery line are used to avoid noise and over-current.

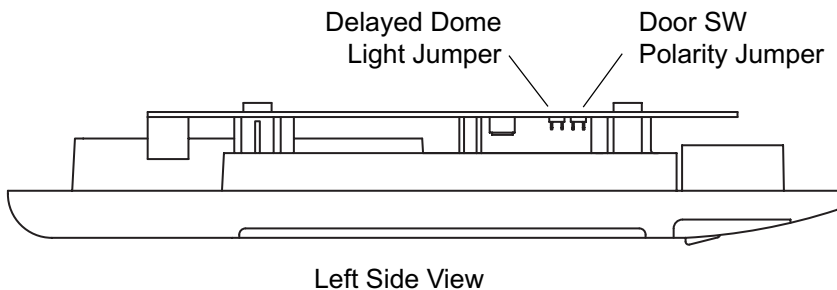

Left Side View

Delayed Dome Light Jumper

This is a jumper to enable to the Delayed Dome Light function. When activated, the Dome light remains ON for 30 seconds after shutting the vehicle's door. However, it immediately turns off when IGN/ACC is turned ON. It can also be turned off using the remote or the external dome light SW . Default is disabled.

Door SW Polarity Jumper

This is a jumper to change the factory door SW polarity. There are two common types of dome light circuits used, positive and negative switched. Default is the Negative Switched System.

IMPORTANT:

When changing the Jumpers above, make sure the BATT (Main Unit) wire has not been connected. The Jumper settings will not be recognized if made while BATT is connected.

Variable Audio Output

The output of this connector can be used to drive an external amplifier/speaker combination. This output will mute when either of the headphone jacks are being used.

SPECIFICATIONS

Specifications

Video Display System	NTSC (PAL available)	
Display Screen	Size	6.8 inches, 5.4”(W) x 4.1”(H)
		4:3 Aspect Ratio
	Element	TFT-LCD, Active Matrix
	Format	6.8”, 1152(W) x 234(H)
	Total	269,568 pixels
Back Light	Cold Cathode Fluorescent Lamp	
Power Requirement	14.4 VDC (11 – 15 VDC allowable)	
Headphone Output	32ohm 100mW(max)	
Video Input (DIN)	1.0V p-p 75ohm	
Audio Input (DIN)	1.0V rms (max)	
Operating Temperature	+32 °F to +122 °F (0 °C to + 50 °C)	
Dimensions	267mm (D) x 228mm (W) x 45mm (H)	
	10.51” (D) x 8.98” (W) x 1.77” (H)	
Weight	1.2 kg (2 lb 10 oz)	

Accessories

RUE-4150 Remote Control	x 1
KWE-508V Mini-DIN Extension Cable with Mini-DIN to RCA interface	x 1
Power Supply Connector	x 1
Variable Audio Out Connector	x 1
AAA batteries	x 2
Velcro Tape	x 1
Screws	x 12

NOTES:

Due to continuous product improvements, specifications and design are subject to change without notice.

The LCD panel is manufactured using an extremely high precision manufacturing technology. Its effective pixel ratio is over 99.99%. This means that 0.01% of the pixels could be either always ON or OFF.

Typical Rear Seat Entertainment System

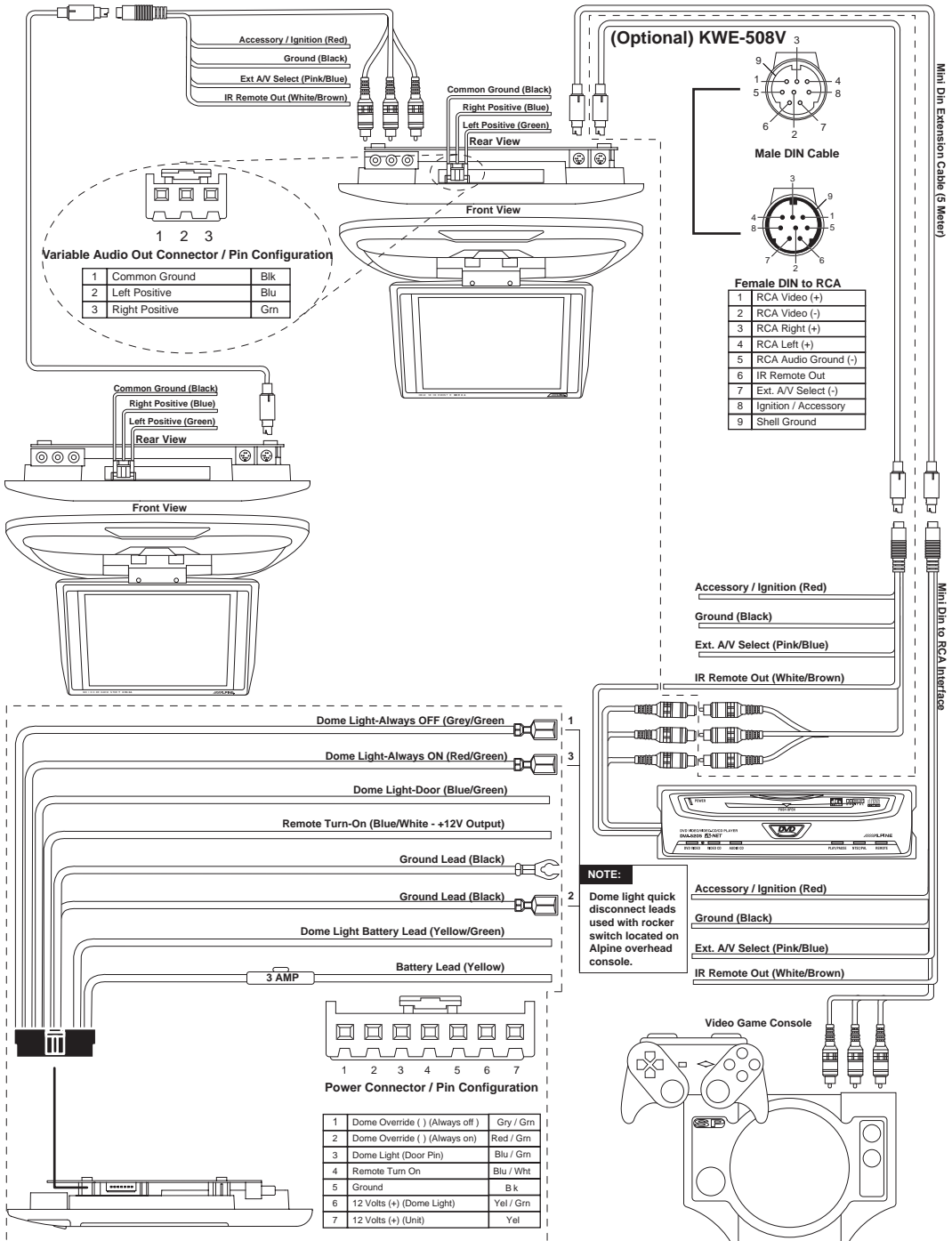

WARNING

It is dangerous and illegal for the driver to watch the TV/Video while driving the vehicle. The driver may be distracted from looking ahead and an accident could occur.



ALPINE ELECTRONICS, INC.

Tokyo office; 1-1-8 Nishi Gotanda,
Shinagawa-ku, Tokyo 141-8501, Japan
Tel.: (03) 3494-1101

ALPINE ELECTRONICS OF AMERICA, INC.

19145 Gramercy Place, Torrance,
California 90501, U.S.A.
Tel.: 1-800-ALPINE1 (1-800-257-4631)
1-888-NAV-HELP (1-888-628-4357)

ALPINE ELECTRONICS OF CANADA, INC.

Suite 203, 7300 Warden Ave. Markham, Ontario
L3R 9Z6, Canada
Tel.: 1-800-ALPINE1 (1-800-257-4631)

ALPINE ELECTRONICS OF AUSTRALIA PTY. LTD.

6-8 Fiveways Boulevard Keysborough Victoria 3173,
Australia
Tel.: (03) 9769-0000

ALPINE ELECTRONICS GmbH

Kreuzerkamp 7-11 40878 Ratingen, Germany
Tel.: 02102-45 50

ALPINE ITALIA S.p.A.

Via C.Colombo 8, 20090 Trezzano
Sul Naviglio MI, Italy
Tel.: 02-48 47 81

ALPINE ELECTRONICS FRANCE S.A.R.L.

98, Rue De La Belle Etoile, Z.I. Paris Nord II B.P.50016
F-95945, Roissy, Charles De Gaulle Cedex, France
Tel.: 01-48 63 89 89

ALPINE ELECTRONICS OF U.K., LTD.

13 Tanners Drive, Blakelands,
Milton keynes MK14 5BU, U.K.
Tel.: 01908-61 15 56

ALPINE ELECTRONICS DE ESPAÑA, S.A.

Portal De Gamarra 36, Pabollón 32
01013 Vitoria(Alava)-Apdo. 133, Spain
Tel.: 34-45-283588